

◇ **Features**

- Negligible reverse recovery
- High-speed switching
- Positive Temperature Coefficient
- Temperature-Independent Switching
- Pb-free / RoHS compliant

650V SILICON CARBIDE
SCHOTTKY DIODE

V_{RRM} 650V

I_F 8A ($T_C=154^\circ\text{C}$)

Q_C 23nC

◇ **Benefits**

- Higher frequency
- Low heat dissipation requirements
- Reduce size and cost of the system
- High-reliability

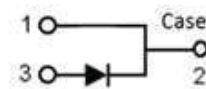
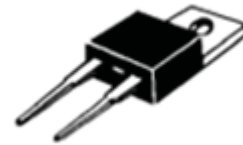

TO-220AC

Maximum Ratings (Tc=25°C unless otherwise noted)

Symbol	Parameter		Value	Unit	Note
V_{RRM}	Repetitive peak reverse voltage		650	V	
I_F	Continuous forward current	Tc=25°C	25	A	Figure 3
		Tc=135°C	11	A	
		Tc=154°C	8	A	
I_{FSM}	Non-repetitive forward surge current	Tc=25°C, $t_p=10\text{ms}$, Half sine pulse	76	A	
		Tc=110°C, $t_p=10\text{ms}$, Half sine pulse	68	A	
I_{FRM}	Repetitive Peak Forward Surge Current	Tc=25°C, $t_p=10\text{ms}$, Half sine pulse	67	A	
$\int i^2 dt$	i^2t value	Tc=25°C, $t_p=10\text{ms}$	32	A ² S	
		Tc=110°C, $t_p=10\text{ms}$	28	A ² S	
P_{tot}	Power Dissipation	Tc=25°C	100	W	Figure 4
		Tc=110°C	43	W	
		Tc=150°C	16	W	
T_j, T_{stg}	Operating and Storage Temperature		-55 to +175	°C	

Electrical Characteristics (Tc=25°C unless otherwise noted)

Symbol	Parameter	Test Conditions	Value			Unit	Note
			Min.	Typ.	Max.		
V_{DC}	DC blocking voltage		650	-	-	V	
V_F	Forward voltage	$I_F=4A$	-	1.18	-	V	Figure 1
		$I_F=8A, T_c=25^\circ C$	-	1.39	1.6	V	
		$I_F=8A, T_c=175^\circ C$		1.74		V	
I_R	Reverse current	$V_R=650V, T_c=25^\circ C$	-	6	60	μA	Figure 2
		$V_R=650V, T_c=175^\circ C$		12		μA	
Q_C	Total capacitive charge	$V_R=400V$	-	23	-	nC	Figure 6
C	Total capacitance	$V_R=1V, f=1MHZ$	-	338	-	pF	Figure 5
		$V_R=200V, f=1MHZ$	-	44	-	pF	
		$V_R=400V, f=1MHZ$	-	43	-	pF	
E_C	Capacitance Stored Energy	$V_R=400V$	-	3.7	-	μJ	Figure 7

Thermal Characteristics

Symbol	Parameter	Value		Unit	Note
		Typ.	Max.		
$R_{th(j-c)}$	Thermal resistance (Junction to case)	1.495	-	$^\circ C/W$	Figure 8

Electrical Characteristic Curves

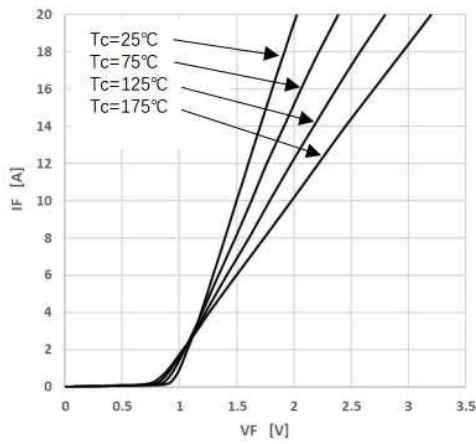

Figure 1 Forward Characteristics

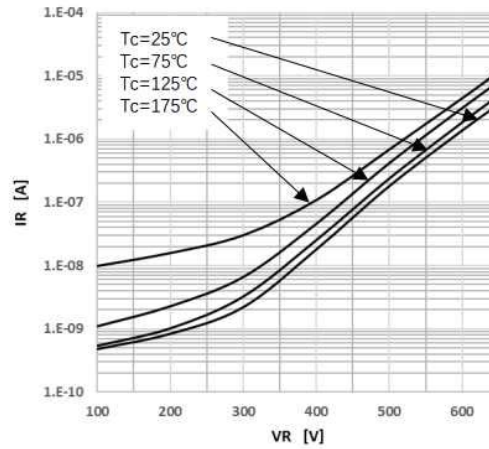

Figure 2 Reverse Characteristics

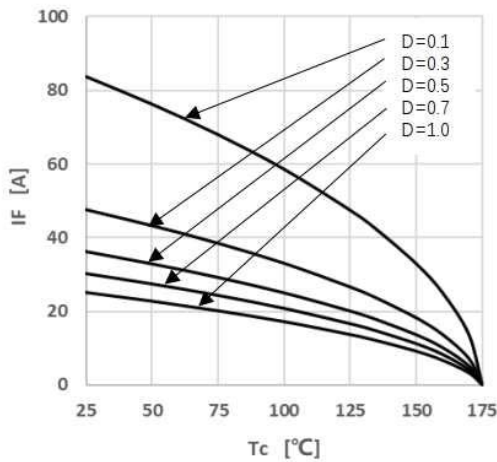

Figure 3 Peak Forward Current Derating

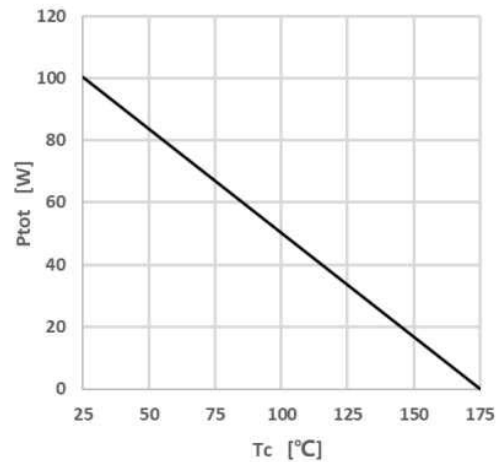

Figure 4 Power Dissipation

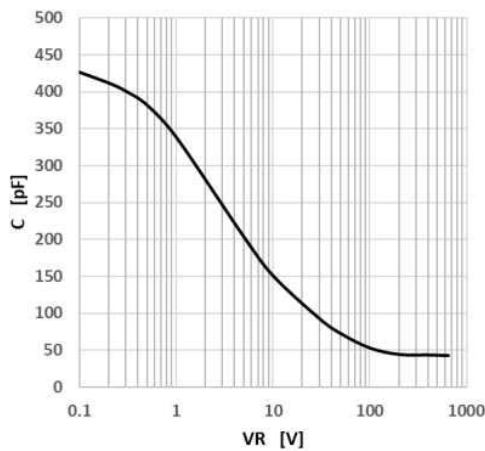

Figure 5 Capacitance vs. Reverse Voltage

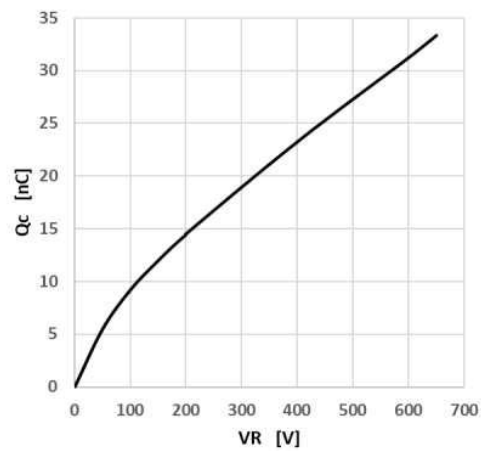

Figure 6 Capacitance Charge vs. Reverse Voltage

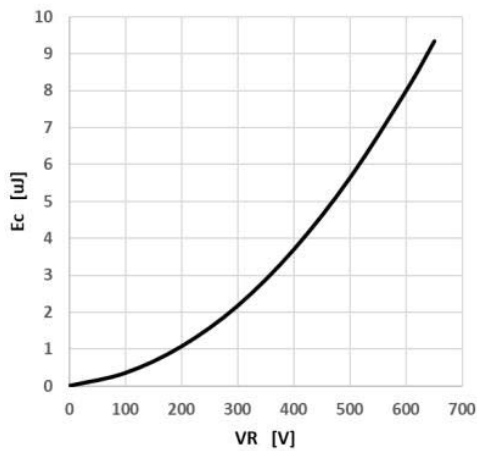

Figure 7 Capacitance Stored Energy

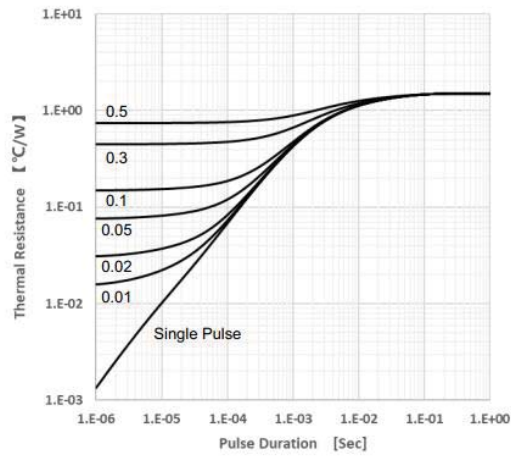
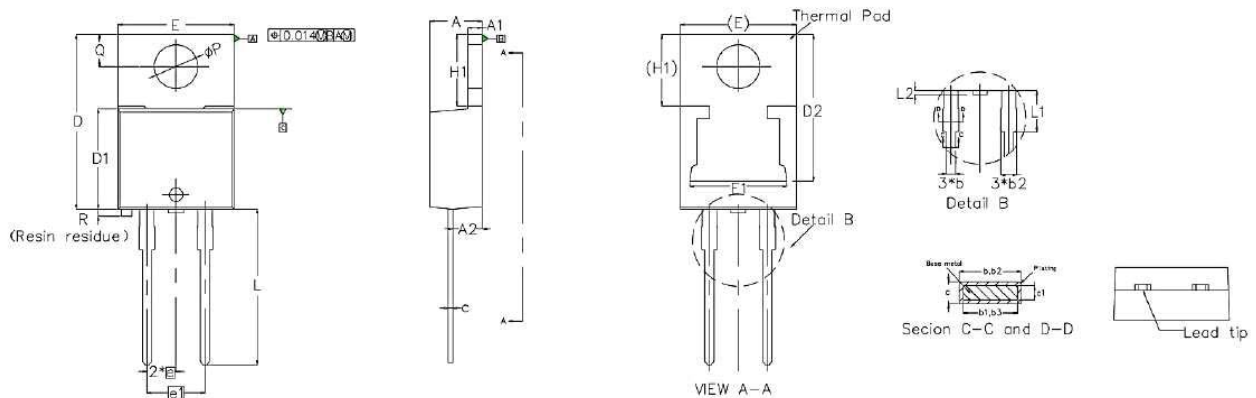

Figure 8 Transient Thermal Impedance

TO-220AC Package Dimensions : (Unit : mm)



SYMBOL	MILLIMETERS			NOTES	SYMBOL	MILLIMETERS			NOTES
	Normal	MIN.	MAX.			Normal	MIN.	MAX.	
A	4.55	4.44	4.65		E1	8.57	8.25	8.89	
A1	1.27	1.14	1.39		e	2.54	2.41	2.67	
A2	2.60	2.54	2.79		e1	5.08	4.95	5.20	
b	0.85	0.69	0.94		H1	6.20	6.09	6.40	
b1	0.83	0.38	0.97		L	13.60	13.52	14.00	
b2	1.33	1.20	1.45		L1	3.60	3.56	3.80	
b3	1.33	1.20	1.45		L2	-	0	0.35	
c	0.50	0.36	0.56		φP	3.80	3.70	3.91	
c1	0.48	0.36	0.56		Q	2.80	2.62	2.87	
D	15.25	14.95	15.32		R			0.2	
D1	8.75	8.50	8.89						
D2	12.85	12.20	13.30						
E	10.18	10.11	10.40						