

◇ **Features**

- Negligible reverse recovery
- High-speed switching
- Positive Temperature Coefficient
- Temperature-Independent Switching
- Pb-free / RoHS compliant

650V SILICON CARBIDE
SCHOTTKY DIODE
 V_{RRM} 650V
 I_F 10A ($T_C=154^\circ\text{C}$)
 Q_C 30nC

◇ **Benefits**

- Higher frequency
- Low heat dissipation requirements
- Reduce size and cost of the system
- High-reliability

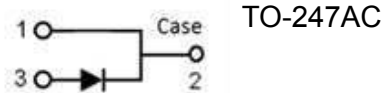

Maximum Ratings (Tc=25°C unless otherwise noted)

Symbol	Parameter		Value	Unit	Note
V_{RRM}	Repetitive peak reverse voltage		650	V	
I_F	Continuous forward current	Tc=25°C	32	A	Figure 3
		Tc=135°C	15	A	
		Tc=154°C	10	A	
I_{FSM}	Non-repetitive forward surge current	Tc=25°C, $t_p=10\text{ms}$, Half sine pulse	92	A	
		Tc=110°C, $t_p=10\text{ms}$, Half sine pulse	88	A	
I_{FRM}	Repetitive Peak Forward Surge Current	Tc=25°C, $t_p=10\text{ms}$, Half sine pulse	85	A	
$\int i^2 dt$	i^2t value	Tc=25°C, $t_p=10\text{ms}$	40	A ² S	
		Tc=110°C, $t_p=10\text{ms}$	38	A ² S	
P_{tot}	Power Dissipation	Tc=25°C	130	W	Figure 4
		Tc=110°C	56	W	
		Tc=150°C	21	W	
T_j, T_{stg}	Operating and Storage Temperature		-55 to +175	°C	

Electrical Characteristics (Tc=25°C unless otherwise noted)

Symbol	Parameter	Test Conditions	Value			Unit	Note
			Min.	Typ.	Max.		
V_{DC}	DC blocking voltage		650	-	-	V	
V_F	Forward voltage	$I_F=5A$	-	1.17	-	V	Figure 1
		$I_F=10A, T_c=25^\circ C$	-	1.37	1.6	V	
		$I_F=10A, T_c=175^\circ C$		1.66		V	
I_R	Reverse current	$V_R=650V, T_c=25^\circ C$	-	5	60	μA	Figure 2
		$V_R=650V, T_c=175^\circ C$		12		μA	
Q_C	Total capacitive charge	$V_R=400V$	-	30	-	nC	Figure 6
C	Total capacitance	$V_R=1V, f=1MHZ$	-	455	-	pF	Figure 5
		$V_R=200V, f=1MHZ$	-	57	-	pF	
		$V_R=400V, f=1MHZ$	-	56	-	pF	
E_C	Capacitance Stored Energy	$V_R=400V$	-	4.9	-	μJ	Figure 7

Thermal Characteristics

Symbol	Parameter	Value		Unit	Note
		Typ.	Max.		
$R_{th(j-c)}$	Thermal resistance (Junction to case)	1.15	-	$^\circ C/W$	Figure 8

Electrical Characteristic Curves

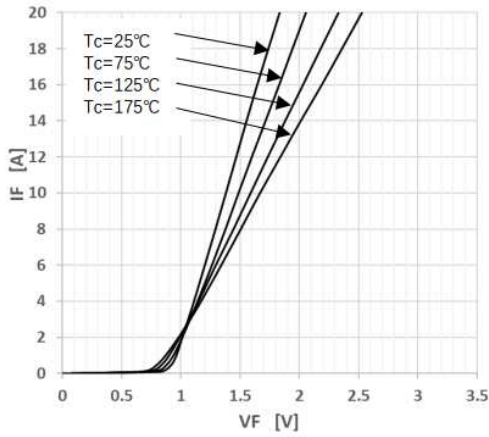

Figure 1 Forward Characteristics

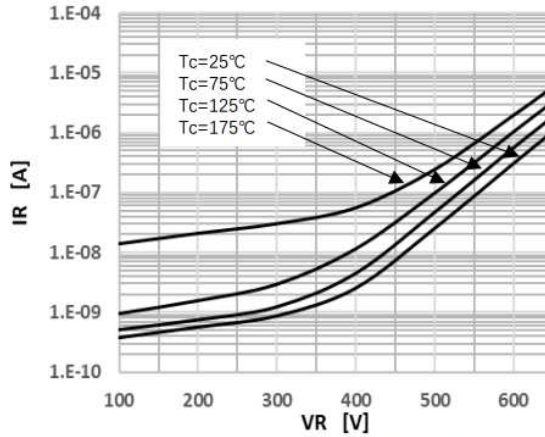

Figure 2 Reverse Characteristics

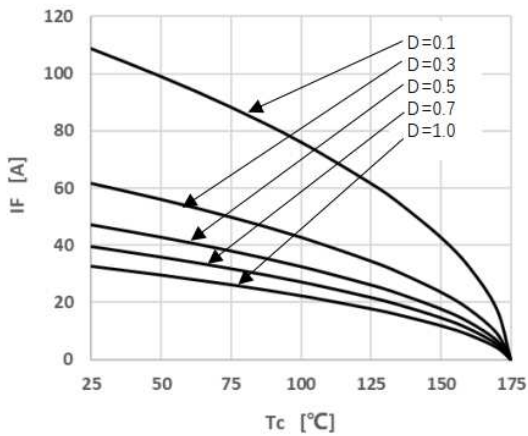

Figure 3 Peak Forward Current Derating

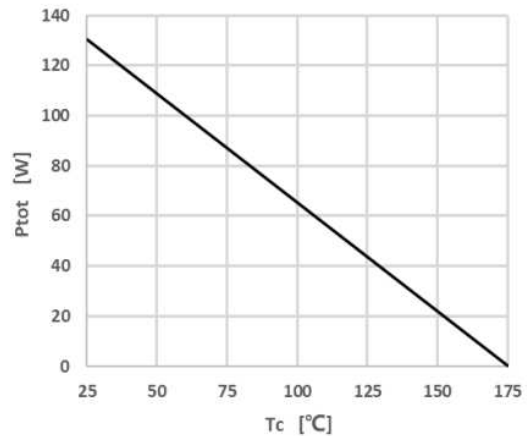

Figure 4 Power Dissipation

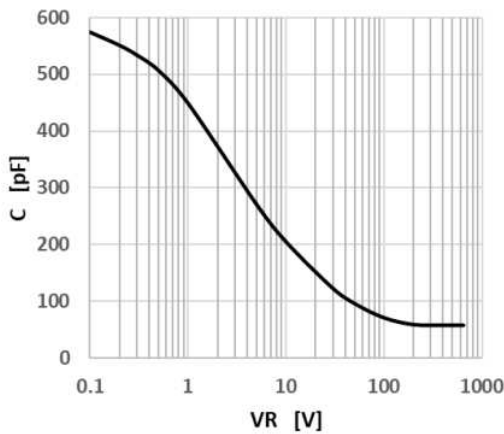

Figure 5 Capacitance vs. Reverse Voltage

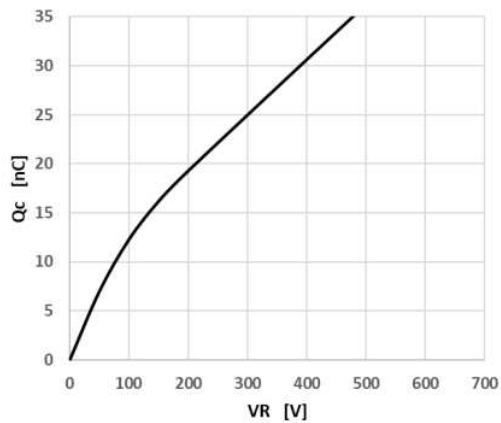

Figure 6 Capacitance Charge vs. Reverse Voltage

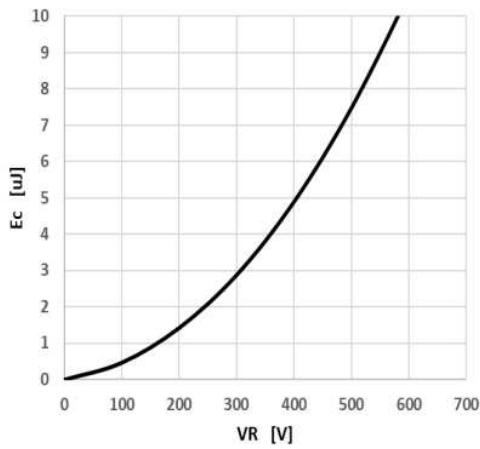

Figure 7 Capacitance Stored Energy

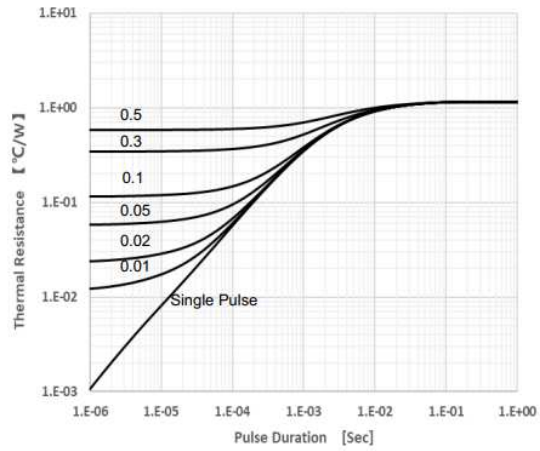
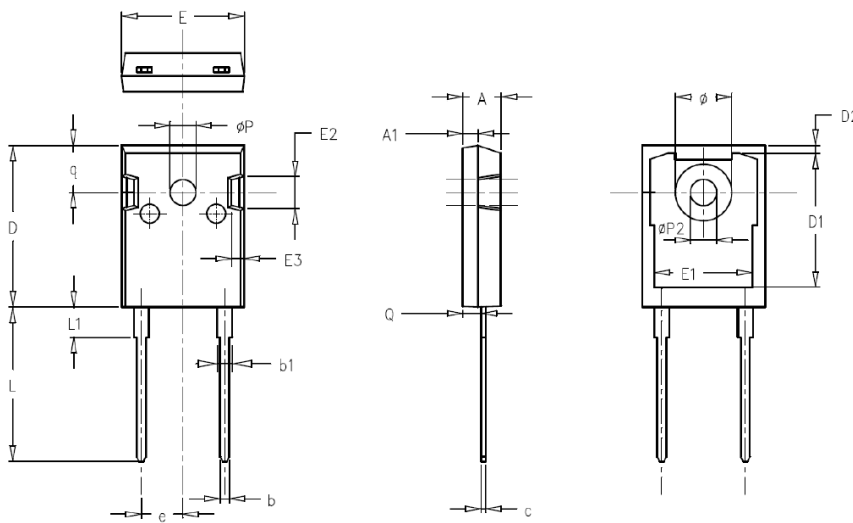

Figure 8 Transient Thermal Impedance

TO-247AC Package Dimensions : (Unit : mm)



SYMBOL	MILLIMETERS			NOTES	SYMBOL	MILLIMETERS			NOTES
	Normal	MIN.	MAX.			Normal	MIN.	MAX.	
A	4.98	4.68	5.36		φP	3.66	3.45	3.85	
A1	1.99	1.90	2.10		e	5.44	BSC		
Q	2.41	2.30	2.60		q	6.24	5.99	6.58	
c	0.60	0.48	0.72		φP2	3.45	3.24	3.64	
b	1.20	1.00	1.40		φ	7.14	7.10	7.30	
b1	2.07	1.90	2.30		D1	16.56	16.10	17.10	
D	21.10	20.80	21.80		D2	0.98	0.80	1.36	
E	15.98	15.38	16.20		E1	13.30	13.00	13.52	
L	20.28	19.50	20.50		E2	5.64	5.10	6.10	
L1	4.01	3.75	4.35		E3	2.33	1.90	2.70	