

◆ Features

- Negligible reverse recovery
- High-speed switching
- Positive Temperature Coefficient
- Temperature-Independent Switching
- RoHS compliant

1200V SILICON CARBIDE
SCHOTTKY DIODE
 V_{RRM} 1200V
 I_F 10A ($T_C=161^\circ\text{C}$)
 Q_C 52nC

◆ Benefits

- Higher frequency
- Low heat dissipation requirements
- Reduce size and cost of the system
- High-reliability

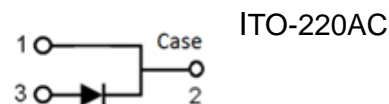

Maximum Ratings ($T_C=25^\circ\text{C}$ unless otherwise noted)

Symbol	Parameter	Value	Unit	Note	
V_{RRM}	Repetitive peak reverse voltage	1200	V		
I_F	Continuous forward current	$T_C=25^\circ\text{C}$	39	A	Figure 3
		$T_C=135^\circ\text{C}$	19	A	
		$T_C=161^\circ\text{C}$	10	A	
I_{FSM}	Non-repetitive forward surge current	$T_C=25^\circ\text{C}$, $t_p=10\text{ms}$, Half sine pulse	64	A	
		$T_C=110^\circ\text{C}$, $t_p=10\text{ms}$, Half sine pulse	51	A	
I_{FRM}	Repetitive Peak Forward Surge Current	$T_C=25^\circ\text{C}$, $t_p=10\text{ms}$, Half sine pulse	55	A	
		$T_C=110^\circ\text{C}$, $t_p=10\text{ms}$, Half sine pulse	45	A	
$\int i^2 dt$	i^2t value	$T_C=25^\circ\text{C}$, $t_p=10\text{ms}$	20	A^2S	
		$T_C=110^\circ\text{C}$, $t_p=10\text{ms}$	15	A^2S	
P_{tot}	Power Dissipation	$T_C=25^\circ\text{C}$	238	W	Figure 4
		$T_C=110^\circ\text{C}$	103	W	
		$T_C=150^\circ\text{C}$	40	W	
T_j, T_{stg}	Operating and Storage Temperature	-55 to +175	$^\circ\text{C}$		

Electrical Characteristics (Tc=25°C unless otherwise noted)

Symbol	Parameter	Test Conditions	Value			Unit	Note
			Min.	Typ.	Max.		
V _{DC}	DC blocking voltage		1200	-	-	V	
V _F	Forward voltage	I _F =5A	-	1.20	-	V	Figure 1
		I _F =10A, Tc=25°C	-	1.43	1.70	V	
		I _F =10A, Tc=175°C	-	2.0	-	V	
I _R	Reverse current	V _R =1200V, Tc=25°C	-	2.0	60	uA	Figure 2
		V _R =1200V, Tc=175°C	-	4.0	-	uA	
Q _C	Total capacitive charge	V _R =800V	-	52	-	nC	Figure 6
C	Total capacitance	V _R =1V, f=1MHZ	-	546	-	pF	Figure 5
		V _R =400V, f=1MHZ	-	47	-	pF	
		V _R =800V, f=1MHZ	-	41	-	pF	
E _C	Capacitance Stored Energy	V _R =800V	-	15.86	-	uJ	Figure 7

Thermal Characteristics

Symbol	Parameter	Value		Unit	Note
		Typ.	Max.		
R _{th(j-c)}	Thermal resistance (Junction to case)	0.63	-	°C/W	Figure 8

Electrical Characteristic Curves

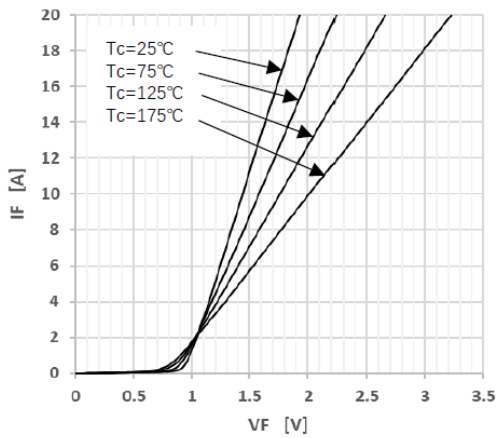

Figure 1 Forward Characteristics

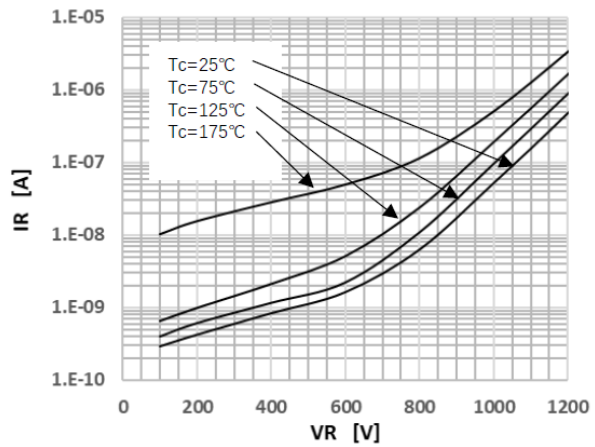

Figure 2 Reverse Characteristics

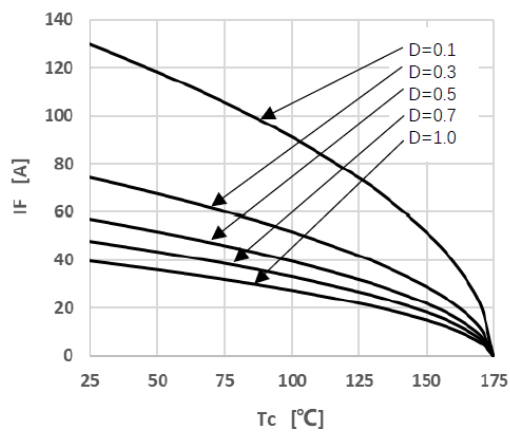

Figure 3 Peak Forward Current Derating

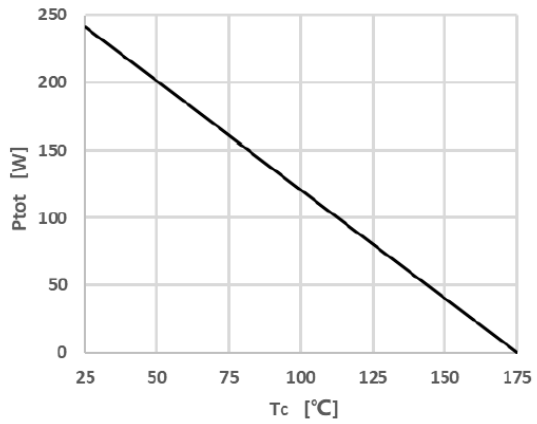

Figure 4 Power Dissipation

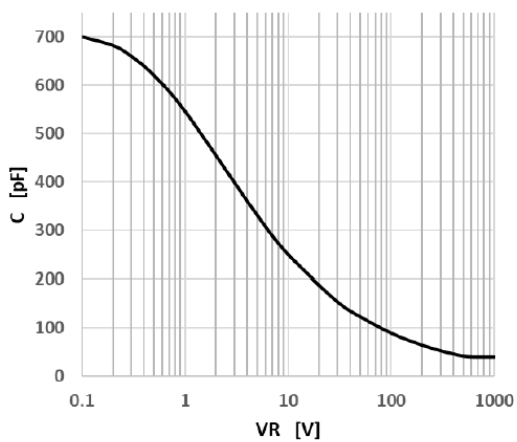

Figure 5 Capacitance vs. Reverse Voltage

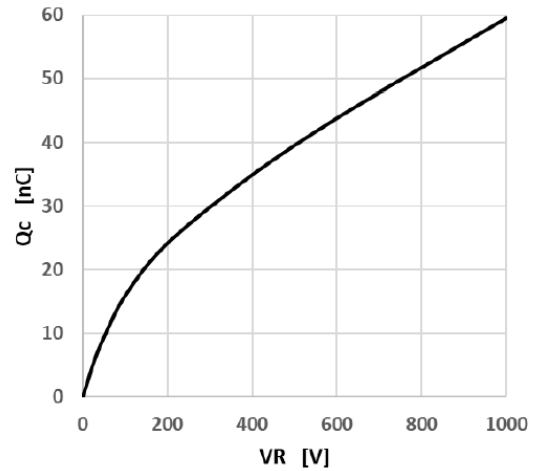

Figure 6 Capacitance Charge vs. Reverse Voltage

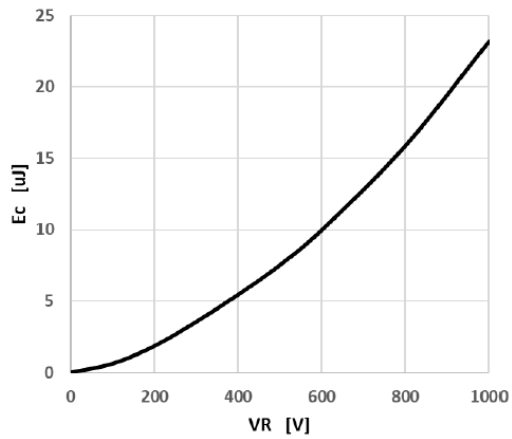

Figure 7 Capacitance Stored Energy

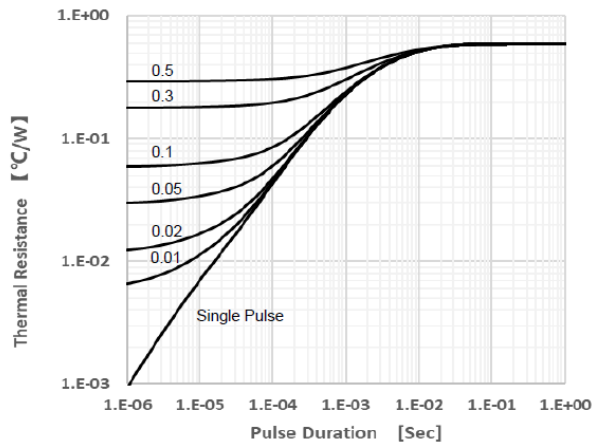
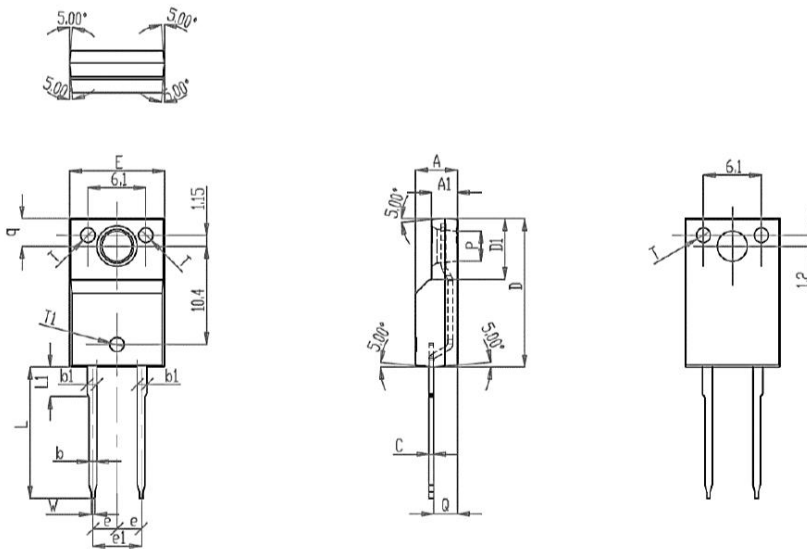

Figure 8 Transient Thermal Impedance

ITO-220AC Package Dimensions : (Unit : mm)



SYMBOL	MILLIMETERS			NOTES	SYMBOL	MILLIMETERS			NOTES
	Normal	MIN.	MAX.			Normal	MIN.	MAX.	
A	4.4	4.2	4.6		e1	5.08	5	5.12	
A1	2.7	2.5	2.9		L	13.90	13.5	14.4	
b	0.8	0.7	0.9		L1	3.12	2.8	3.3	
b1	1.07	0.9	1.3		P	3.14	3.00	3.20	
C	0.5	0.4	0.6		Q	2.44	2.3	2.6	
D	15.63	15.4	15.8		q	2.87	2.6	3	
D1	6.22	6	6.4		W	0.37	0.3	0.5	
E	10.06	9.7	10.3		T	1.52	1.3	1.7	
e	2.54	2.5	2.58		T1	1.20	1.1	1.3	