



Direct Channel Worldwide Corp.

8F., No. 14, San Ming Rd., Shindian City, Taipei County 231,
Taiwan (R.O.C)
T: 886 2 8911 3828 F: 886 2 8911 3829

ER2A-L THRU ER2J-L

Features

- Lead Free Finish/RoHS Compliant(Note 1) ("P" Suffix designates RoHS Compliant. See ordering information)
- Halogen free available upon request by adding suffix "-HF"
- Epoxy meets UL 94 V-0 flammability rating
- Moisture Sensitivity Level 1
- Built-in strain relief
- Super fast switching speed under 35ns
- Marking : Cathode band and type number (No '-L' Suffix)

2 Amp Super Fast Recovery Rectifier 50 to 600 Volts

Maximum Ratings

- Operating Temperature: -65°C to +175°C
- Storage Temperature: -65°C to +175°C

Part Number	Maximum Recurrent Peak Reverse Voltage	Maximum RMS Voltage	Maximum DC Blocking Voltage
ER2A-L	50V	35V	50V
ER2B-L	100V	70V	100V
ER2D-L	200V	140V	200V
ER2G-L	400V	280V	400V
ER2J-L	600V	420V	600V

DO-214AA (SMB) (LEAD FRAME)

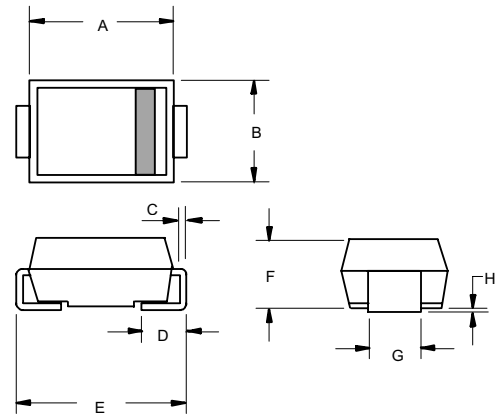

Electrical Characteristics @ 25°C Unless Otherwise Specified

Average Forward Current	$I_{F(AV)}$	2.0A	$T_L = 110^\circ\text{C}$
Peak Forward Surge Current	I_{FSM}	50A	8.3ms, half sine
Maximum Instantaneous Forward Voltage ER2A-L-ER2D-L ER2G-L ER2J-L	V_F	.95V 1.25V 1.70V	$I_{FM} = 2.0A;$
Maximum DC Reverse Current At Rated DC Blocking Voltage	I_R	5 μ A 0.35mA	$T_A = 25^\circ\text{C}$ $T_A = 125^\circ\text{C}$
Maximum Reverse Recovery Time	T_{rr}	35ns	$I_F=0.5A, I_R=1.0A,$ $I_{rr}=0.25A$
Typical Junction Capacitance	C_J	15pF	Measured at 1.0MHz, $V_R=4.0V$

DIM	DIMENSIONS				NOTE
	INCHES		MM		
	MIN	MAX	MIN	MAX	
A	.160	.185	4.06	4.70	
B	.130	.155	3.30	3.94	
C	.006	.012	0.15	0.31	
D	.030	.060	0.76	1.52	
E	.200	.220	5.08	5.59	
F	.079	.096	2.00	2.44	
G	.075	.087	1.91	2.21	
H	.002	.008	0.05	0.203	

SUGGESTED SOLDER PAD LAYOUT

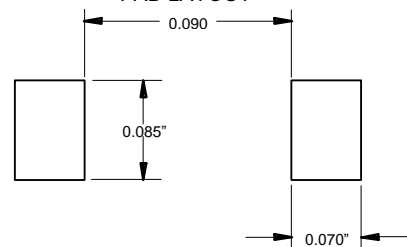

Notes: 1. High Temperature Solder Exemption Applied, see EU Directive Annex Notes 7.



ER2A-L thru ER2J-L

FIG.1-TYPICAL FORWARD CHARACTERISTICS

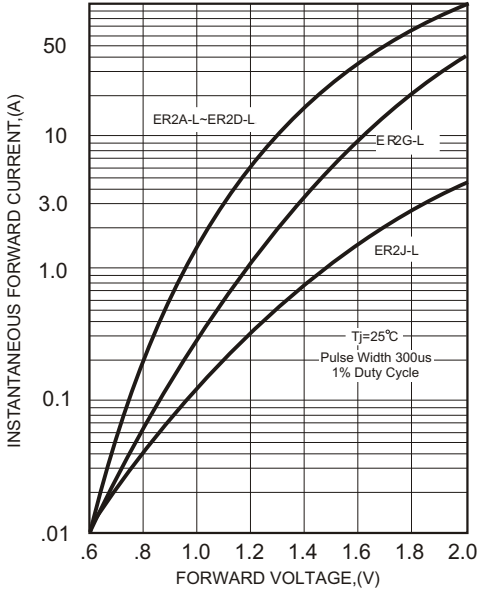

FIG.2-TYPICAL FORWARD CURRENT DERATING CURVE

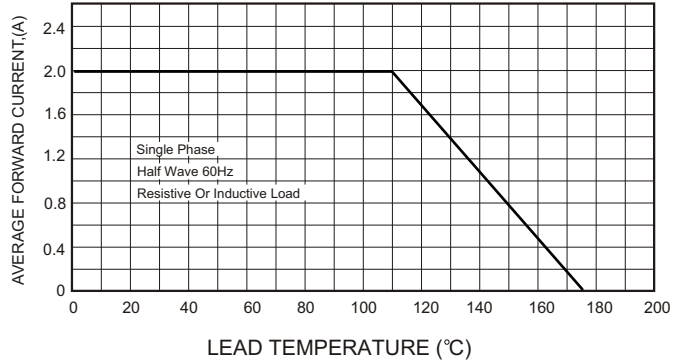

FIG.4-MAXIMUM NON-REPETITIVE FORWARD SURGE CURRENT

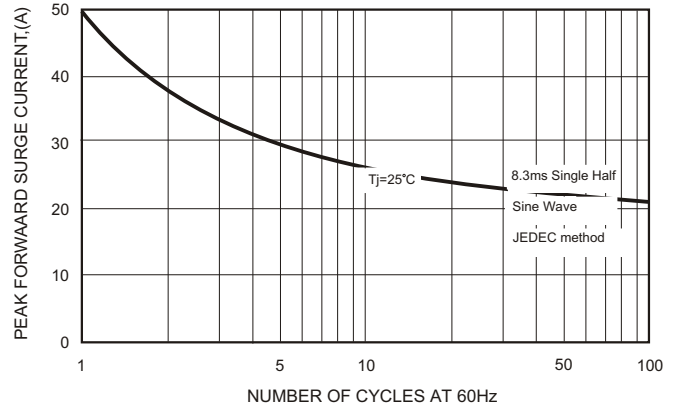
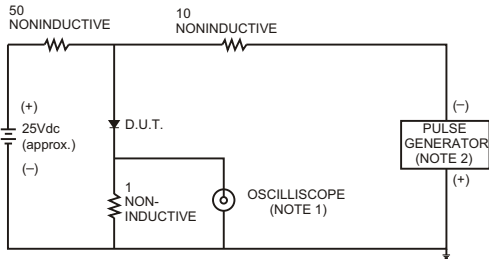

FIG.3- TEST CIRCUIT DIAGRAM AND REVERSE RECOVERY TIME CHARACTERISTICS



NOTES: 1. Rise Time= 7ns max., Input Impedance= 1 megohm.22pF.
2. Rise Time= 10ns max., Source Impedance= 50 ohms.

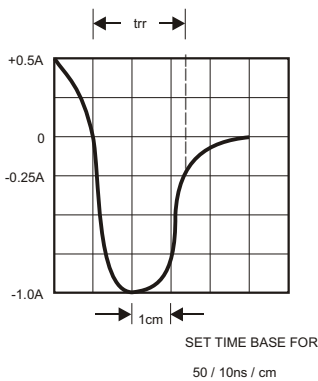

FIG.5-TYPICAL JUNCTION CAPACITANCE

